

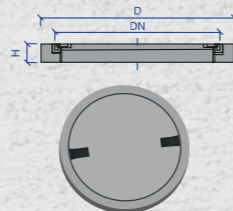

## ŠACHTOVÉ PREFABRIKÁTY

### Betónovo-liatinové poklopy BEGU DN 600

Označenie	D	DN	H	Hmotnosť (kg)
BEGU A 1,5t	750	640	70	72
BEGU B 12,5t	750	625	125	108
BEGU D 40t	786	625	160	160



## BETÓNOVÉ A ŽELEZOBETÓNOVÉ RÚRY

### Betónové rúry hrdlové

Označenie	DN	L	D	t	Hmotnosť kg
TBH 60/250	600	2500	884	100	1360
TBH 80/250	800	2500	1155	115	2090
TBH 100/250	1000	2500	1421	130	2970
TBH 120/250	1200	2500	1710	150	4190

### Železobetónové rúry hrdlové

TZH 60/250	600	2500	884	100	1390
TZH 80/250	800	2500	1155	115	2130
TZH 100/250	1000	2500	1421	130	3010
TZH 120/250	1200	2500	1710	150	4230

### Betónové rúry hrdlové

Označenie	Min. únosnosť (kN/m)
TBH 60/250	88
TBH 80/250	75
TBH 100/250	86
TBH 120/250	78



### Železobetónové rúry hrdlové

Označenie	Min. únosnosť (kN/m)
TZH 60/250	238
TZH 80/250	177
TZH 100/250	154
TZH 120/250	145

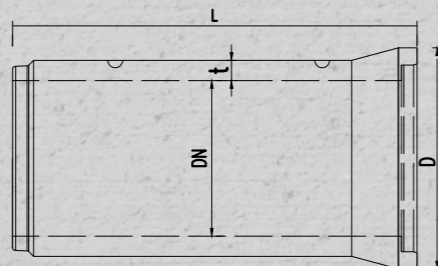

PREFA invest, a.s.  
Podhradská cesta 2  
038 52 Sučany  
www.prefa-su.sk

DN vnútorný priemer  
L stavebná dĺžka  
t hrúbka steny

D vonkajší priemer



# NOVÝ Kanalizačný program

Kvalita, inovácie, skúsenosti



### Šachtové dno

Označenie	DN	H	H1	t	max DN potrubia	D	Hmotnosť kg
TBS 100/45	1000	300	515	150	150	1300	1124
TBS 100/50	1000	350	565	150	200	1300	1216
TBS 100/55	1000	400	615	150	250	1300	1290
TBS 100/60	1000	450	665	150	300	1300	1362
TBS 100/70	1000	550	765	150	400	1300	1493
TBS 100/80	1000	650	865	150	500	1300	1612
TBS 100/100	1000	850	1065	250	600	1500	2646

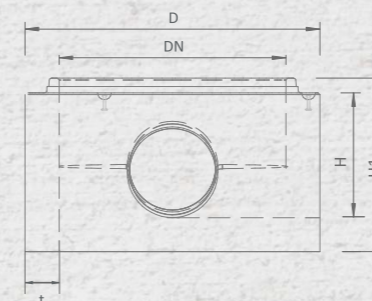

### Skruže

Označenie	DN	H	H1	t	DN 1	D	Hmotnosť kg
TBH 100-25/9	1000	250	-	90	-	1180	178
TBH 100-50/9	1000	500	-	90	-	1180	363
TBH 100-100/9	1000	1000	-	90	-	1180	732
TBH 100-25/12	1000	250	-	120	-	1240	247
TBH 100-50/12	1000	500	-	120	-	1240	500
TBH 100-100/12	1000	1000	-	120	-	1240	1006

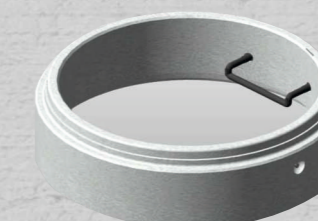
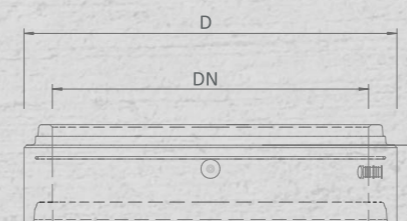

### Kónus

Označenie	DN	H	H1	t	DN 1	D	Hmotnosť kg
TBS 100-62,5-60/9	625	650	670	90	1000	1180	488
TBS 100-62,5-60/12	625	650	670	120	1000	1240	640

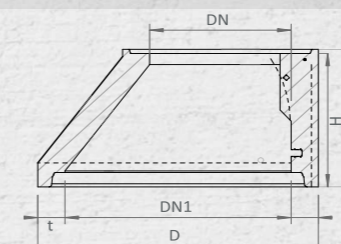

### Prechodové dosky

Označenie	DN	H	H1	t	DN 1	D	Hmotnosť kg
TZD 100-62,5/29	625	270	290	120	1000	1240	506
TZD 100-62,5/19	625	170	190	120	1000	1240	290
TZD 100-62,5/13	625	110	130	120	1000	1240	160

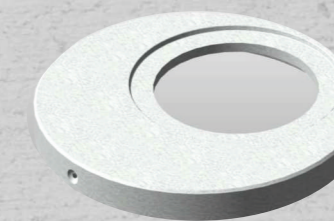
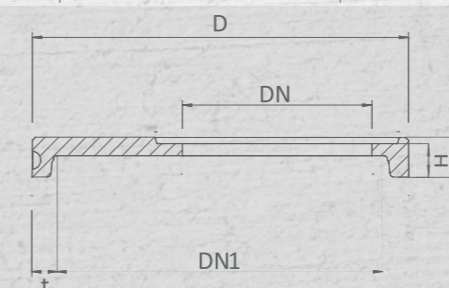

### Prstence

Označenie	DN	H	H1	t	DN 1	D	Hmotnosť kg
TBS 62,5/4	625	40	-	120	-	865	27
TBS 62,5/6	625	60	-	120	-	865	40
TBS 62,5/8	625	80	-	120	-	865	54
TBS 62,5/10	625	100	-	120	-	865	67
TBS 62,5/12	625	120	-	120	-	865	80

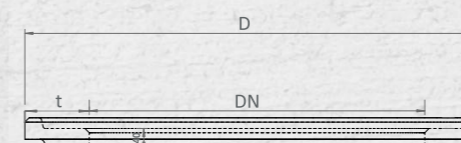

H stavebná výška  
DN, DN1 vnútorný priemer  
t hrúbka steny

H1 celková výška  
D vonkajší priemer